

SmartCell

A new era in compact fire detection



Why Choose SmartCell?

Wireless fire detection, developed by EMS, has been protecting countless buildings, properties and people for over 30 years.

With the launch of SmartCell comes our latest innovation.

SmartCell is a "smart" fire system, designed for small to medium sized installations.

With a capacity of 64 wireless devices, SmartCell is just right to meet many applications.

A Kidde company

Now part of Kidde Global Solutions, EMS SmartCell is available in many countries, across the globe.

SmartCell is more than just a wireless fire system. It brings the technology to add many other products, as well as our innovative SmartCell Services package, that will provide users and service companies with instant information by text and email.

If you want to explore the world of SmartCell and how it could be your solution, take a journey with us.

- ◆ **High speed installation** - due to SmartCell's intuitive design and the plug-and-play benefits of "going wireless", rapid deployment is made possible for minimum disruption.
- ◆ **Proven technology** - Our next generation wireless technology, SmartCell is based on decades of EMS technology and know-how.
- ◆ **Meets, or exceeds, all standards** - SmartCell was designed to meet today's demanding requirements. It is fully third-party certified to all relevant current EN standards.
- ◆ **Take & play** - The flexibility of SmartCell means that the system can be altered if the building's use or occupation changes.
- ◆ **Remote monitoring** - With optional communications module with SIM and Ethernet connectivity options.
- ◆ **Information devices** - SmartCell also accommodates information devices, allowing third-party peripherals to be monitored, for notification separately from the system's fire devices.



Typical SmartCell Applications

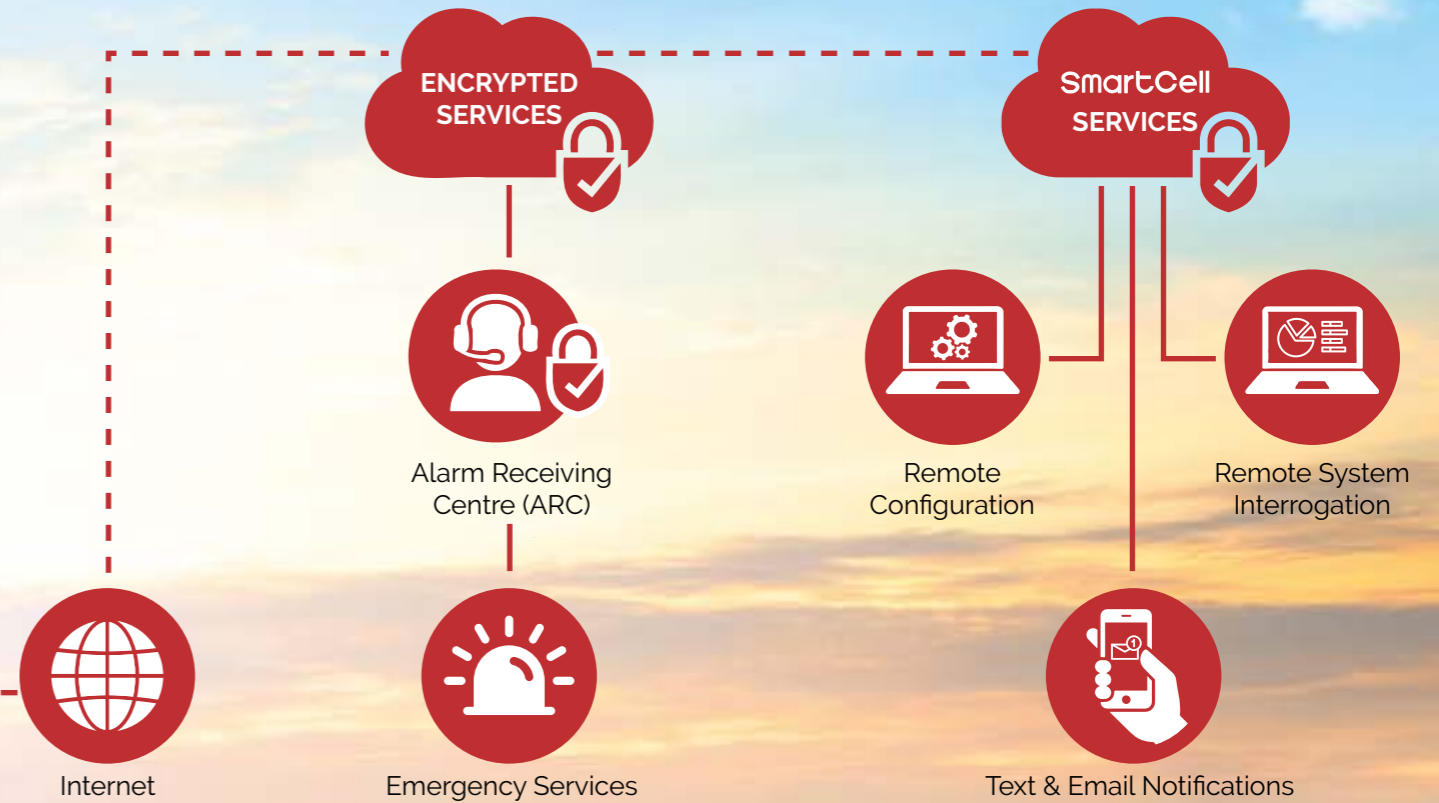
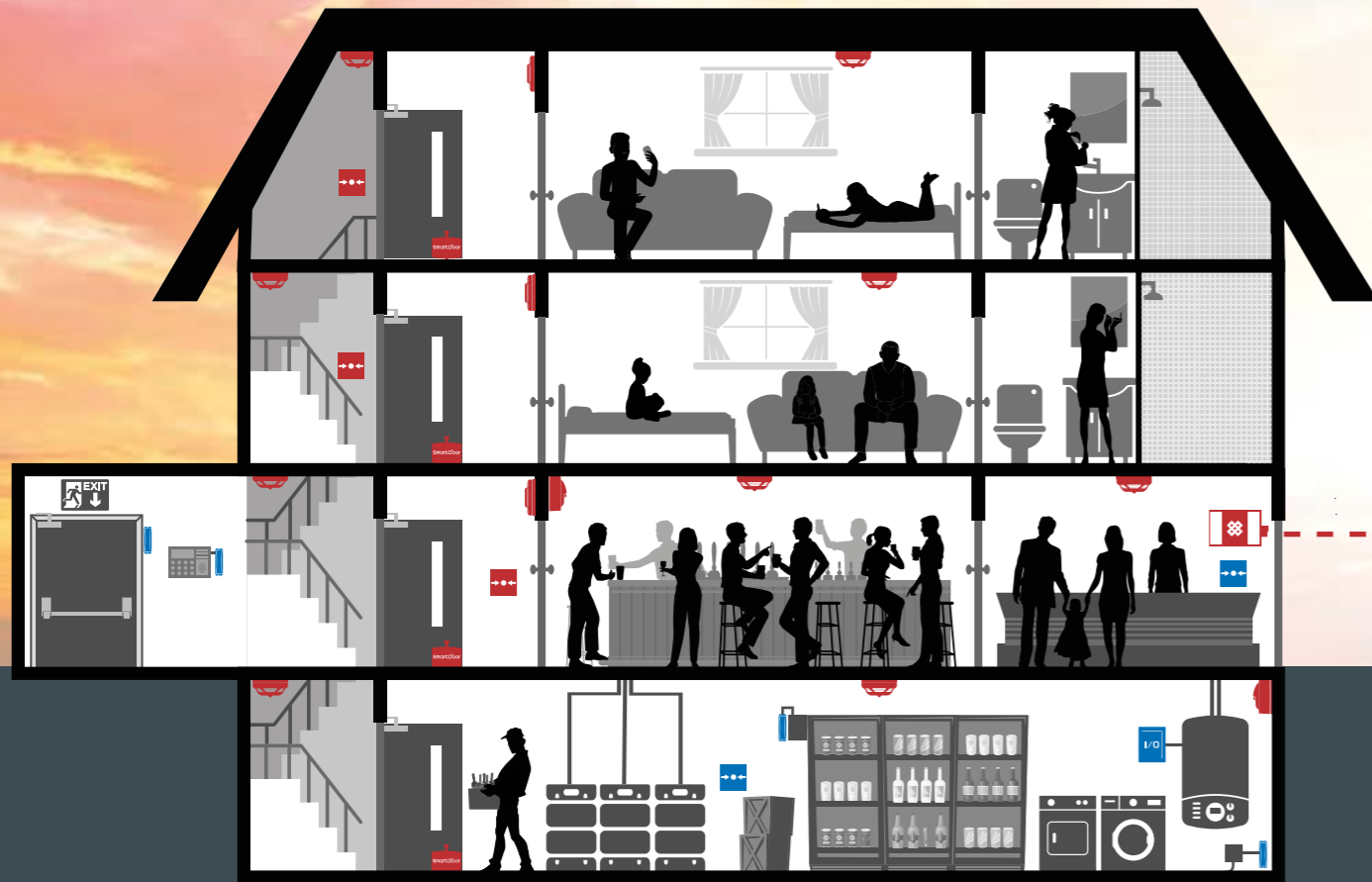

Wireless Detector - can also include sounders and visual alarms in one single compact device

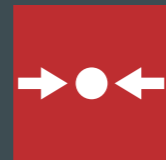

Wireless Manual Call Point - complete with clear anti-tamper covers



Wireless Remote Indicator - used to quickly locate the source of an alarm signal from detectors, which may not easily accessible or visible.



Wireless Input / Output Unit - with two resistor monitored inputs and two voltage free outputs, this device can be connected to third-party devices for fire or information alerts.



Wireless Sounder - available for wall or ceiling mounting and can include integrated visual alarm notification.



Wireless SmartDoor - fully controlled by the SmartCell control panel, SmartDoor holds fire doors open, and automatically releases them in a fire event.



Wireless Information Contact Transmitter and Input Device - used for monitoring third-party devices for either a "call for assistance" or for an alert of a non-fire emergency.

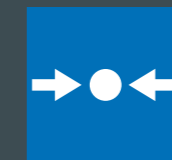

Wireless Information Manual Call Point - complete with clear anti-tamper covers, this device is either used as a panic alarm, or to summon assistance.

Big On Features

Each wireless device is compact in design yet has many elements. The combination detector has the ability to detect both heat and smoke, along with a 32 tone sounder and a EN54:23 visual indicator. All this in one single device.

Each wireless device has integral "low cost" batteries, giving at least 3 years operation under normal operating conditions.

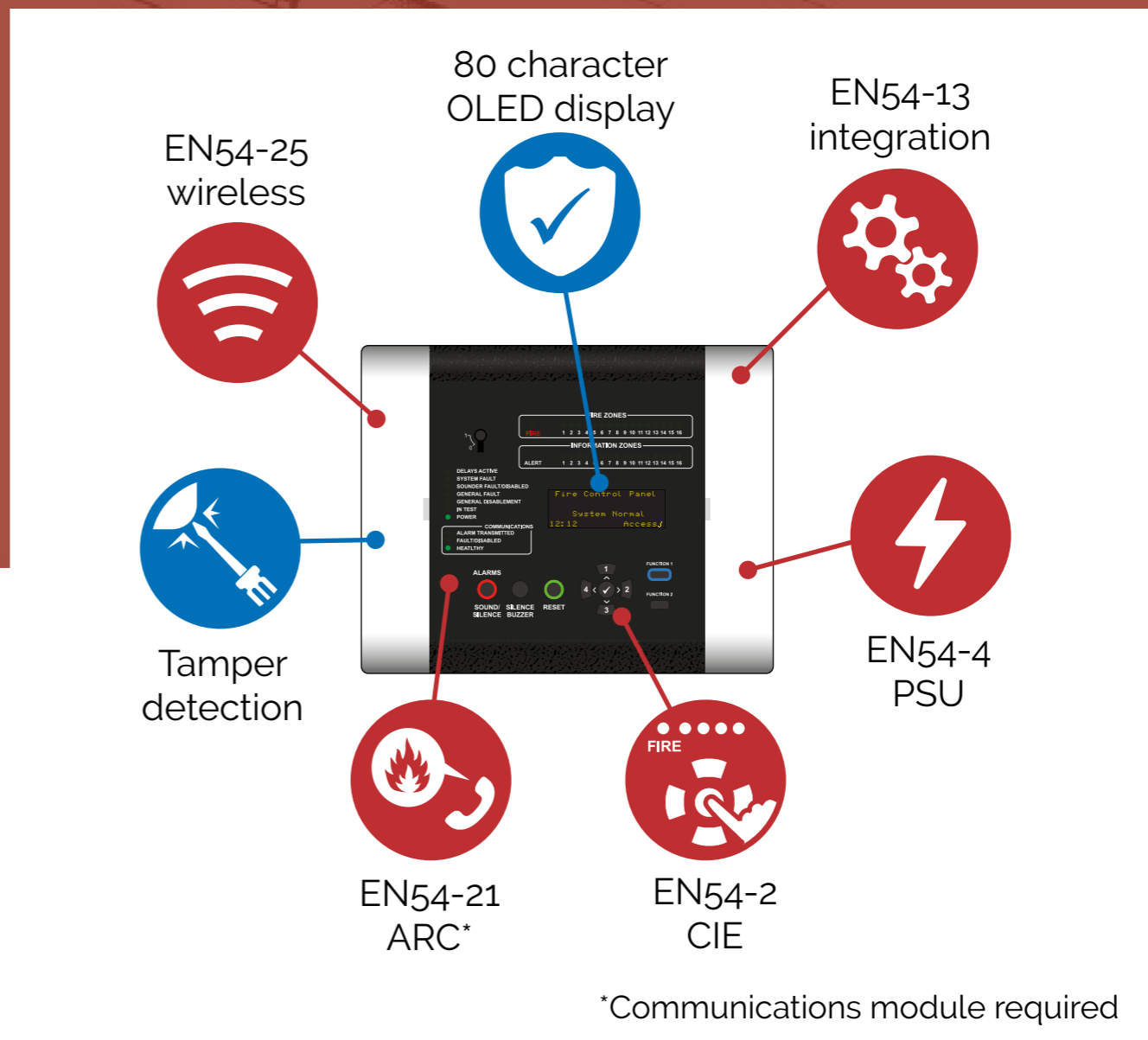
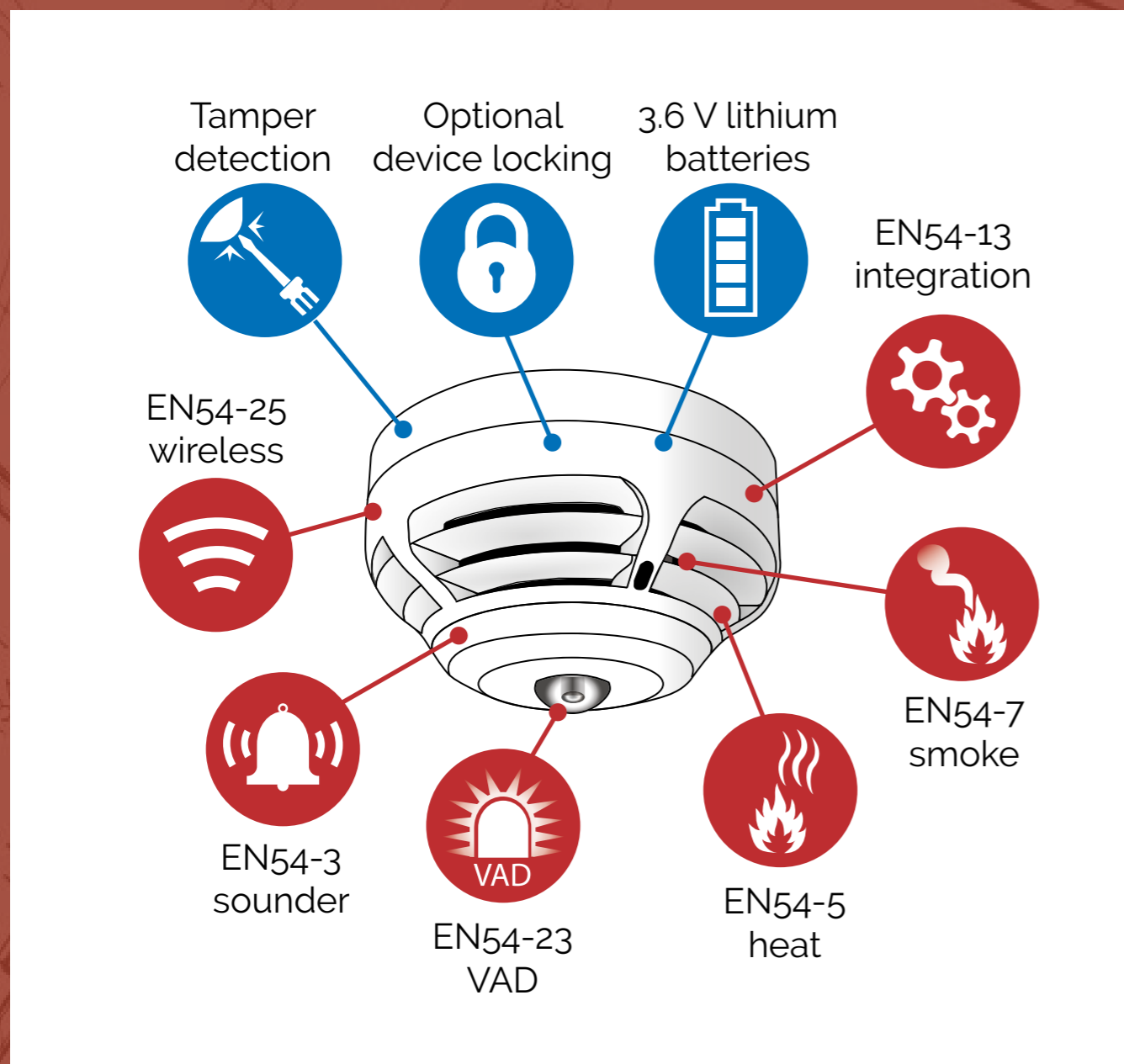

The SmartCell Control Panel itself is fully self-contained, and the optional communications module, which provides access to SmartCell Services, is simply connected to the main PCB.

Available in either 24 VDC or 230 VAC power configurations, the SmartCell Control Panel can accommodate up to 64 wireless devices.

Third-party certified to all current relevant European standards, the SmartCell Control Panel also includes an 80 character OLED display, showing comprehensive device location information and intuitive menu structures, ensuring swift ease of use.

Much like the wireless devices, the control panel is small, sleek and packed with features.

Core SmartCell Fire Devices

Wireless Fire Control Panel

- ◆ Compact design
- ◆ 80 character OLED display
- ◆ Remote connection plus SMS/email updates
- ◆ Multi-language support



Wireless Manual Call Point

- ◆ Compact design
- ◆ Fully wireless
- ◆ Information variant also available



Wireless Detector Sounder-Beacon

- ◆ Compact design
- ◆ Fully wireless
- ◆ Includes part 23 beacon
- ◆ Also available without sounder & beacon



Wireless Sounder-Beacon

- ◆ Compact design
- ◆ Fully wireless
- ◆ Available in ceiling or wall variant
- ◆ Red or white finish
- ◆ Sounder only variant also available
- ◆ Information variant also available



Wireless SmartDoor

- ◆ Holds doors in an open position
- ◆ Doors automatically close in a fire event
- ◆ Full SmartCell system integration
- ◆ Black or white finish



SmartCell Services

SmartCell, provides users not only with robust fire detection, but with next generation communications and remote services.

Additionally, SmartCell integrates other important site services wirelessly and seamlessly, providing users with instant information, via text or email. For example, it could be of heating or cooling systems status, or perhaps localised flooding of plant or hotel rooms.

This technology platform pioneered by EMS also provides the ability to remotely diagnose any issues as they occur, rather than potentially attending site unequipped. This can lead to significant site visit reduction, with associated cost savings and the benefits of reduced carbon footprint.

SmartCell Services offers comprehensive features for both the end user, and the service provider.



24/7 monitoring



Real estate visibility



Site visit reduction



Cost saving



Peace of mind



Instant notification

Information Devices

SmartCell is unique in that information devices can be added and monitored separately from fire devices at the control panel.

White "information" manual call points and sounders can be installed and used as a "call for assistance", or to alert of a non-fire emergency.

Compatible third-party equipment can also be connected, using the SmartCell wireless input transmitter.

Additionally, texts and emails can be generated if any equipment connected fails to operate, allowing relevant engineers to be alerted seamlessly.

Imagine an issue with water ingress in a hotel guest room. The flood detector operates and generates a local alarm. The building owner already has a plumbing service contract in place, so a text or email is sent directly to the contractor. The problem is swiftly resolved and damage is kept to a minimum.

Our SmartCell Services package ensures comprehensive system information is available immediately, upon demand, and is protected by end-to-end encryption.



Typical monitoring applications:



Flood detection



Emergency lighting

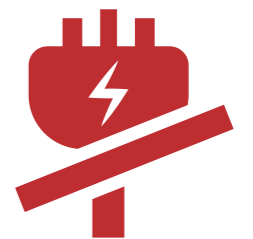

Mains loss



Humidity sensing



Boiler faults



Assistance

SmartCell Services

Info alert at Grand Beach Hotel:
FLOOD WARNING: Guest room 18

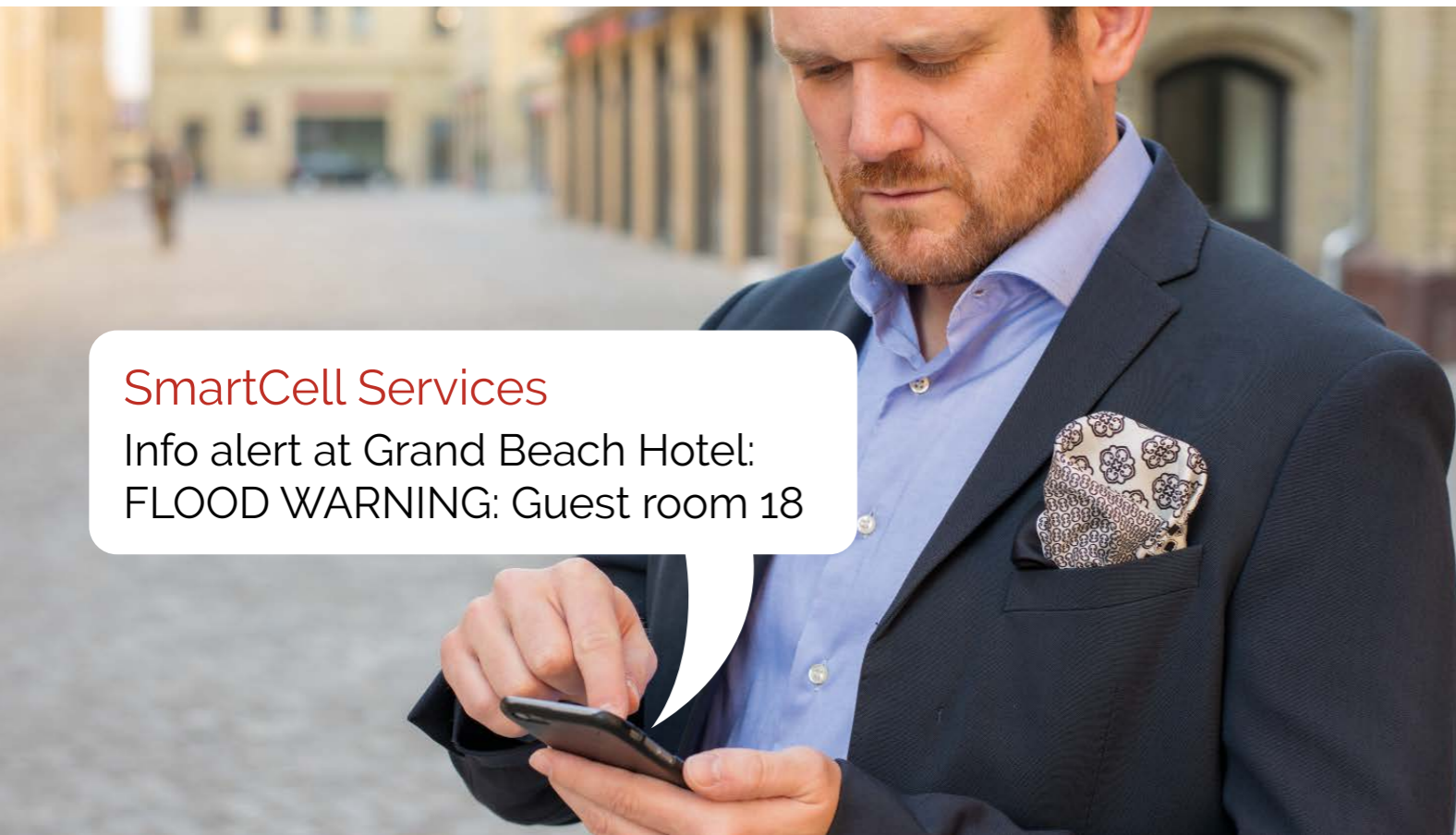



WIRELESS FIRE SYSTEMS

www.mysmartcell.com